





# 340 □ Z1 S □ □ 2

- |    |   |   |
|----|---|---|
| 06 | 0   | 0   |
| 07 | 1   | 1   |
| 08 | 2   | 2   |
| 09 | 3   | 4   |
| 10 |  | 5   |
| 11 |   |  |
| 12 |   |   |
| 13 |   |   |
| 14 |   |   |
| 15 |   |   |
| 16 |   |   |
| 17 |   |   |
| 18 |   |   |
| 19 |   |   |
| 20 |   |   |











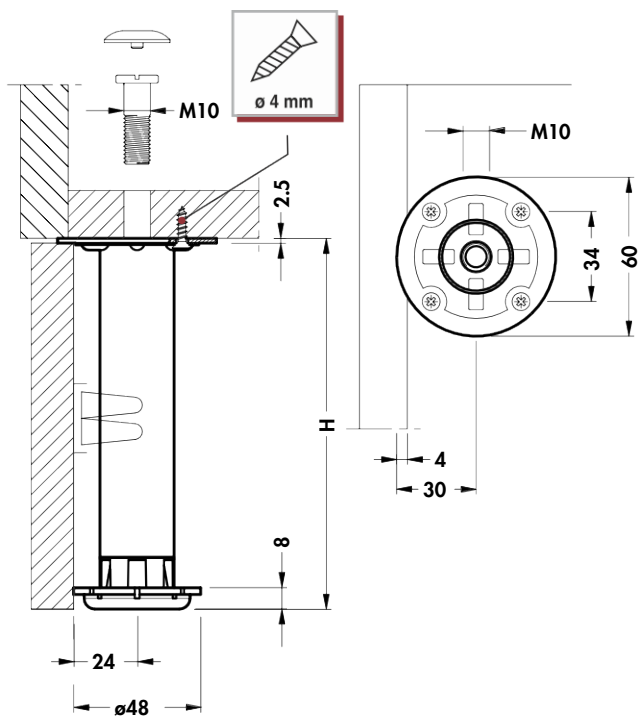

H<sub>cm</sub>

+20mm 0mm			Ø28mm
	ABS	Fe	ZAMAK

 800 H<sub>cm</sub> 08-10-12-15

 1600 H<sub>cm</sub> 06-07-09-11-13-14-16-17-18-19-20



9		1	868 00 Z1 S1 00		556
		2	868 00 Z1 S2 00		556
		3	868 00 Z1 S3 00		557
9		1	810 37 01 00 00		548
		2	810 37 02 00 00		548
		4	810 37 04 00 00		548
		5	810 37 55 00 00		548
		9		202	504
203	505				
204	506	H 9-20			
225	508				
226	509-510				
228	512				
230	513-514				
235	515				