











# 817 AU ZV 1B

□ □  
DX  
SX  





**FOR YOUR SAFETY WARNING**

kg ?  
[www.camar.it/warning](http://www.camar.it/warning)

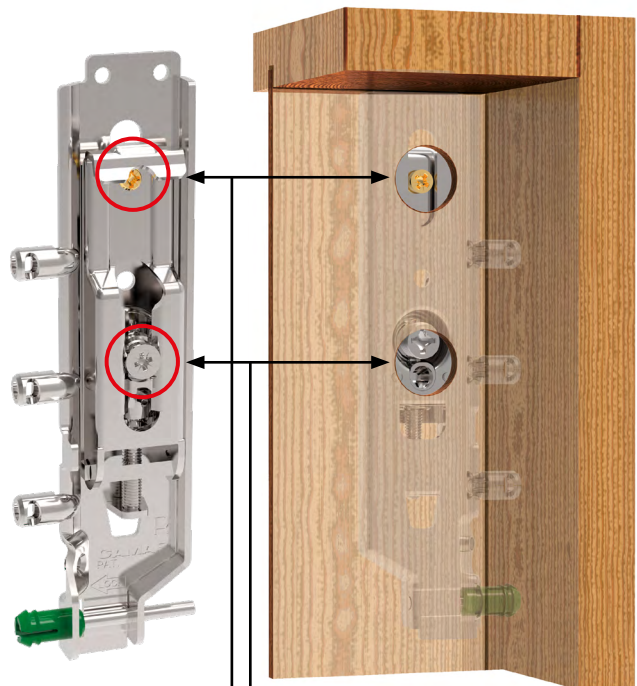
 3D	 25 mm	 18 mm		Fe
ZAMAK		 PH2	 PZ2	
 100	 3000	 1000		



**New**



 25 mm

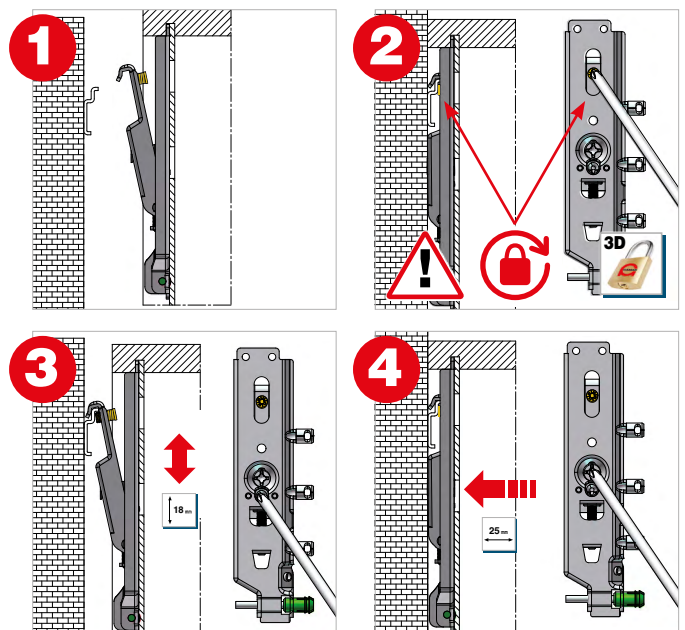

 18 mm

**875 AS**





  =  3D



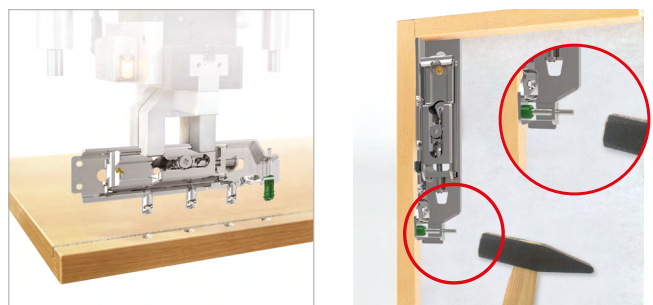



  After assembly, verify that the anti-drop system has been activated.

  Verificare dopo il montaggio l'avvenuta attivazione del sistema antisgancio.



9		BRACKET PLATE BP 15mm	875 AS Z1 00 47	 674
			875 AS Z1 00 60	 674
			875 AS Z1 □ □	 674-675
			875 AS Z1 20 32	 675

9		810 00 □ 18 20	 645
		810 1B □ 20 12	 650
		810 1B □ 20 14	 651
		810 BG □ 18 21	 642