

801 22 ZV IN

DX
SX





New

READ BEFORE USING



FOR YOUR SAFETY WARNING



kg ?
www.camar.it/warning

3D  19 mm  22 mm   Fe

PA6

 200  6000  1200

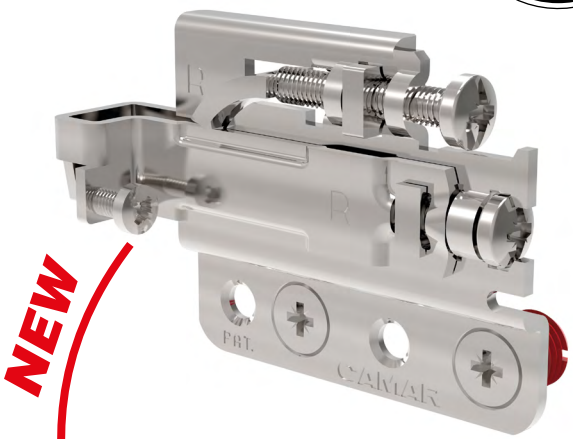

NEW



875 AS



+

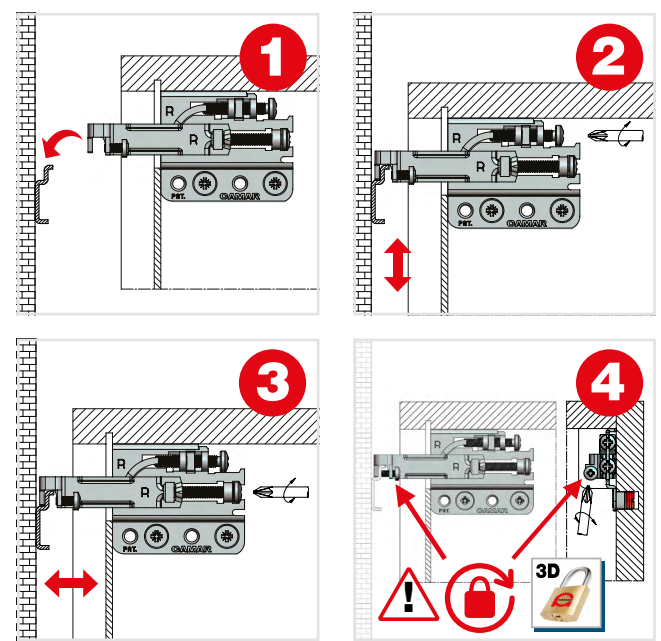





=



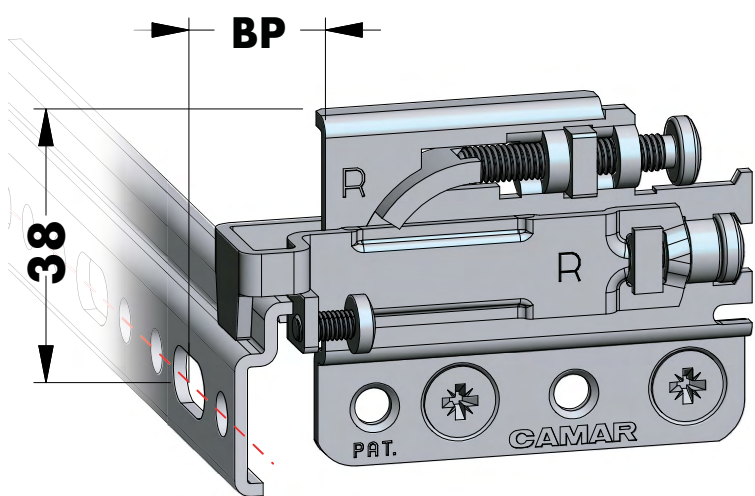

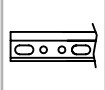
  After assembly, verify that the anti-drop system has been activated.

  Verificare dopo il montaggio l'avvenuta attivazione del sistema antigancio.



9		BRACKET	875 AS Z1 00 47		674
		PLATE	875 AS Z1 00 60		674
			875 AS Z1 □ □ □ □		674-675
			875 AS Z1 20 32		675

9		801 00 P2 AP 00		626
		807 00 P2 MA 00		630

9		801 00 □ □ 00 □ □		627
---	---	-------------------	---	-----