

# 801 12 Z1 VP

DX  
SX  

**New**

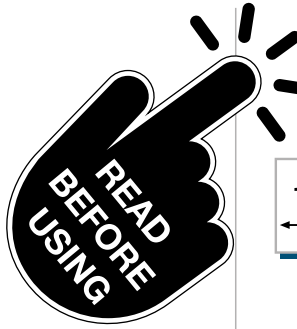





**FOR YOUR SAFETY WARNING**

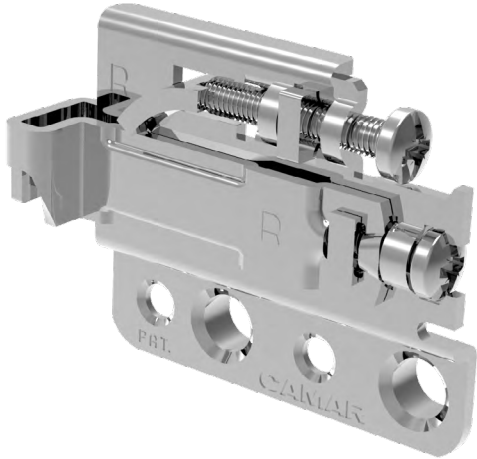

**kg ?**  
[www.camar.it/warning](http://www.camar.it/warning)

19 mm    22 mm        Fe







 200     6000     1200

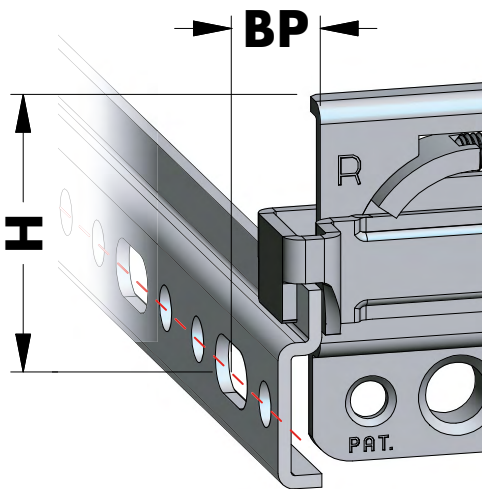

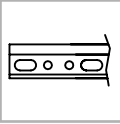
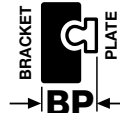



801 00  00 

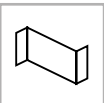

9		<b>k</b>	<b>BRACKET</b>  <b>PLATE</b> <b>BP</b>	<b>H</b>	
		870	3	9	38
	873	3	9,5	37	669
	874	3	9	37	669
	875	3	9	38	670-675
	875 AC Z1 LA 60	3	13	38	670

9  807 00 P2 MA 00  630

9  801 00  00   627