

423 □ P2 0X 07

- A6 = 6,5
 - A7 = 7,5
 - A8 = 8,5
 - A9 = 9,5
 - B0 = 10,5
 - B1 = 11,5
 - B2 = 12,5
 - B3 = 13,5
 - B4 = 14,5
 - B5 = 15,5
 - B6 = 16,5
- H_{cm}**

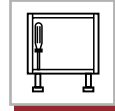

+15mm
0mm











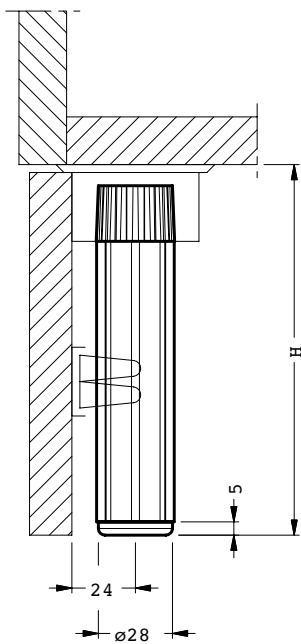

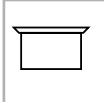
Ø28mm

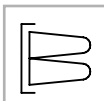

ABS

 3000



2			835 		
9		202  H 9,5-16,5	203  H 10,5-16,5	204  H 10,5-16,5	225  H 10,5-16,5
		226  H 10,5-16,5	228  H 10,5-16,5	230  H 10,5-16,5	235  H 10,5-16,5