

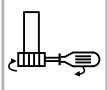

# 396 □ Z1 S □ □ 2

- |    |   |   |
|----|---|---|
| 10 | 0   | 0   |
| 11 | 1   | 1   |
| 12 | 2   | 2   |
| 13 | 3   | 4   |
| 14 |  | 5   |
| 15 |   |  |
| 16 |   |   |
| 17 |   |   |
| 18 |   |   |
| 19 |   |   |
| 20 |   |   |
- H<sub>cm</sub>**

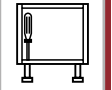







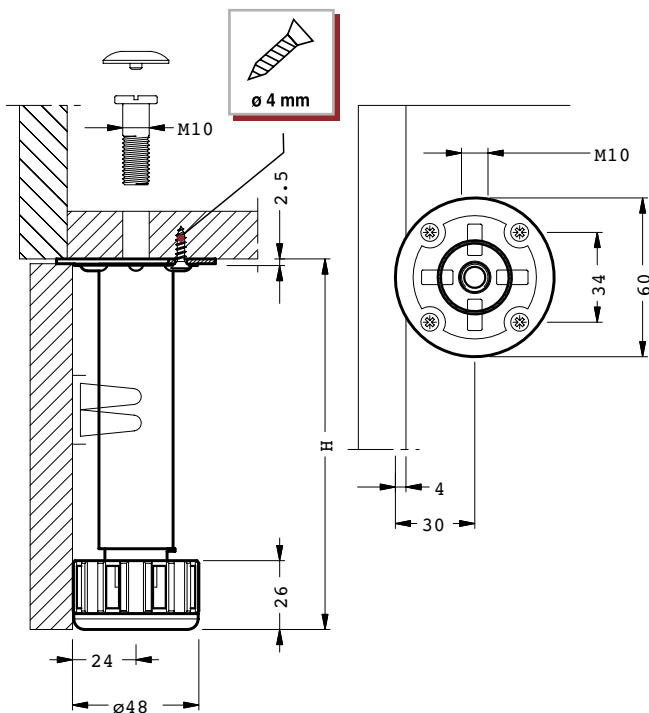











+20mm -20mm			Ø28mm	
	ABS	Fe	PA6	ZAMAK

 800 **H<sub>cm</sub>** 10-12-15

 **1600** **H<sub>cm</sub>** 11-13-14-16-17-18-19-20



9		1	868 00 Z1 S1 00		666
		2	868 00 Z1 S2 00		666
		3	868 00 Z1 S3 00		667
9		1	810 37 01 00 00		656
		2	810 37 02 00 00		656
		4	810 37 04 00 00		656
		5	810 37 55 00 00		656
		9		202	203
					
		H 9-20		H 10-20	
		226	228	230	235
					
		607-609	611	612-613	614